

Article number: 2310431117

Description: E+G Levelling elements
LX.25-SW13-SST-M8X54

Measures

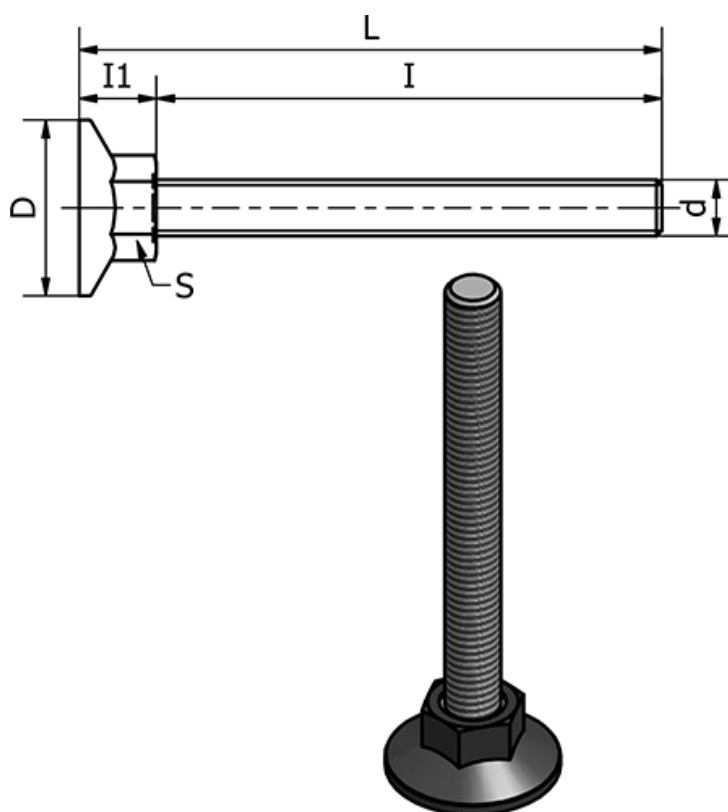

d = M8

D = 25

I = 54

I1 = 11

L = 63

S = 13

Static load in (N) = 2500

Type = AISI 304 Rustfast

Weight (g) = -